

Adaptive Optics Scanning Laser Ophthalmoscope for Retinal Imaging

Ben Moon

Tuesday, March 31, 2020

Active Perception Lab Meeting

Does a person's foveal cone density impact their performance and eye movements during high acuity visual tasks?

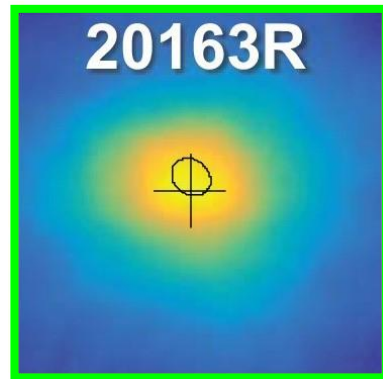
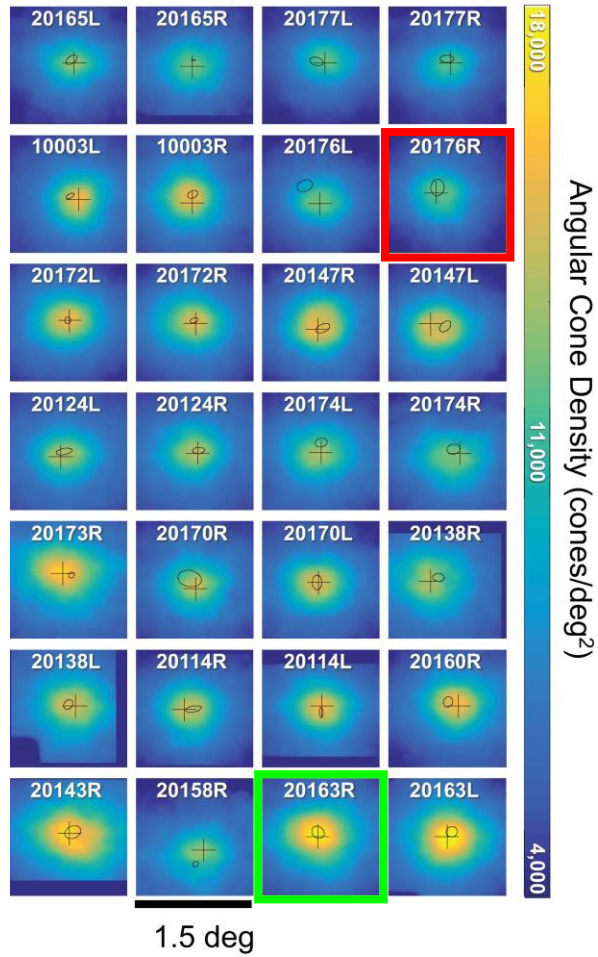

- There is a sizable difference in peak cone density between these two subjects
- How would their eye movements during a high acuity visual task compare?
- To study these questions, we need a way to measure each subject's foveal cone density map
- Ideally, we would get maps like these for all eye tracking subjects

Adaptive optics enables the capture of high-resolution images required for assessing cone density within the foveola

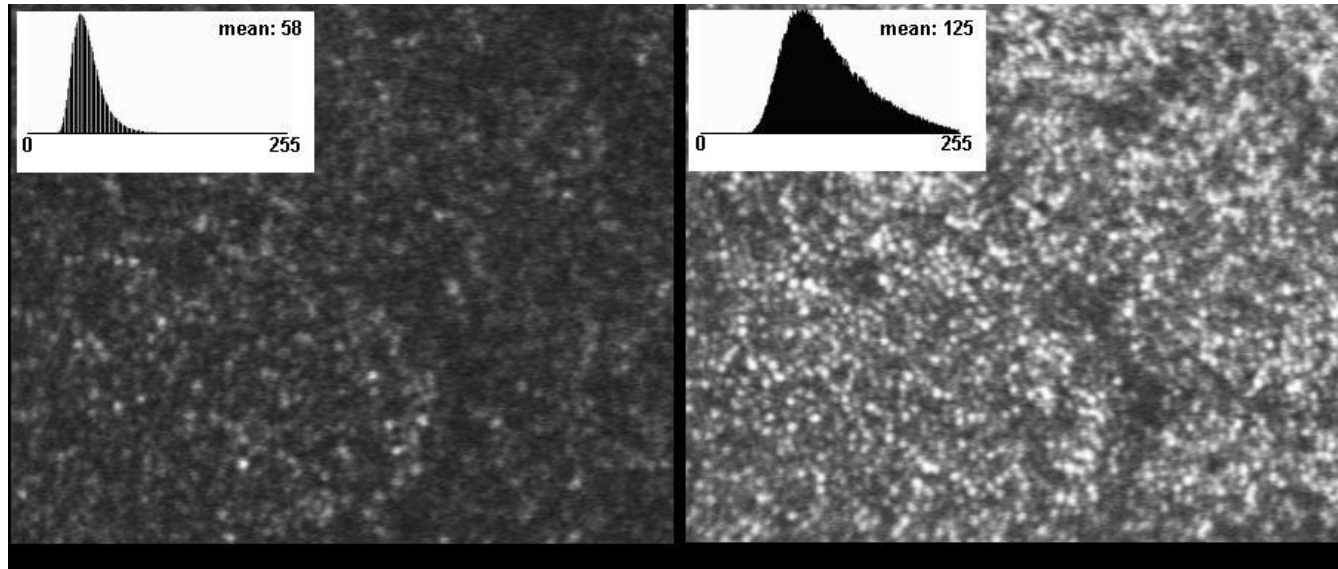

Without AO

individual cones not visible

much lower brightness
(low SNR)

With AO

individual cones visible

much brighter
(high SNR)

- Without adaptive optics, the image quality is not good enough to see individual cones in the foveola
- Cone density measurements will not be accurate unless the acquired images show smallest foveal cones

Outline

- Scanning laser ophthalmoscopes for retinal imaging
- Adaptive optics for retinal imaging
 - Need for adaptive optics
 - Implementation
- Overview of optical design for this system
- Progress update
 - Completed work
 - Plan for working remotely
- Laser safety considerations

Scanning ophthalmoscopes provide superior depth sectioning due to confocal pinhole

Flood illumination

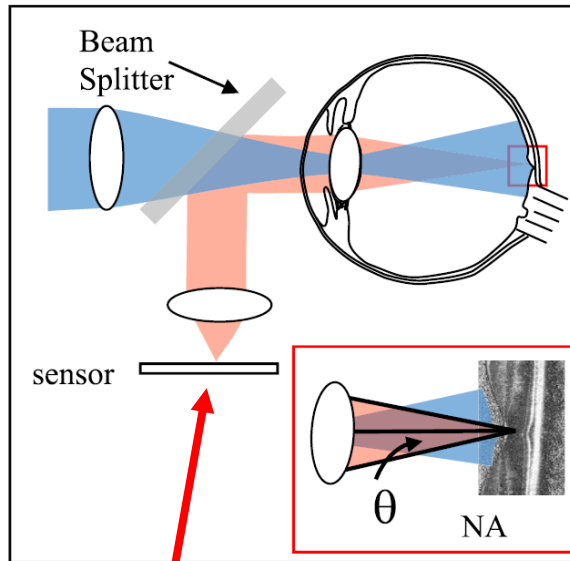

2D camera captures entire image at once
out-of-focus light adds blur to image

Scanning

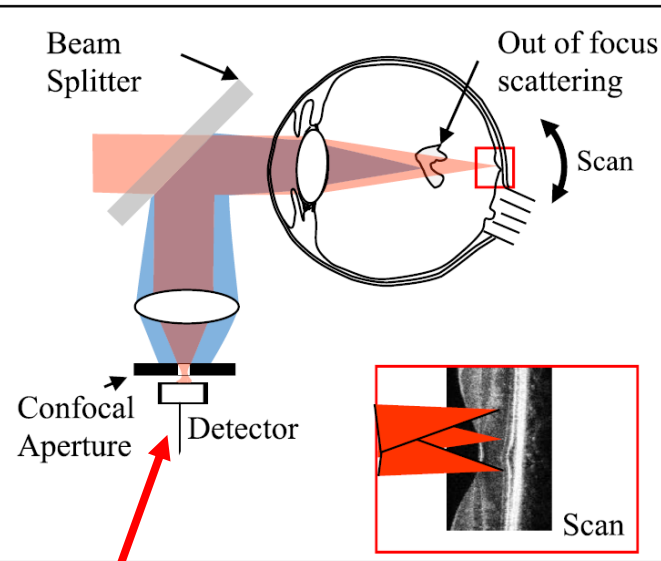

high-sensitivity single-pixel detector
confocal pinhole blocks most out-of-focus light

Benefits of scanning system:

- Less blur from out-of-focus light, so better depth sectioning
- Detector can have much higher sensitivity
- Speed only limited by scanning speed

Drawbacks of scanning system:

- Optical design is usually more complex
- Scanning artifacts can distort the image

Adaptive optics can compensate for the aberrations of the eye, which yields high-resolution images



For a perfect eye, the focused spot of light on the retina gets smaller as pupil size increases

Adaptive optics can compensate for the aberrations of the eye, which yields high-resolution images

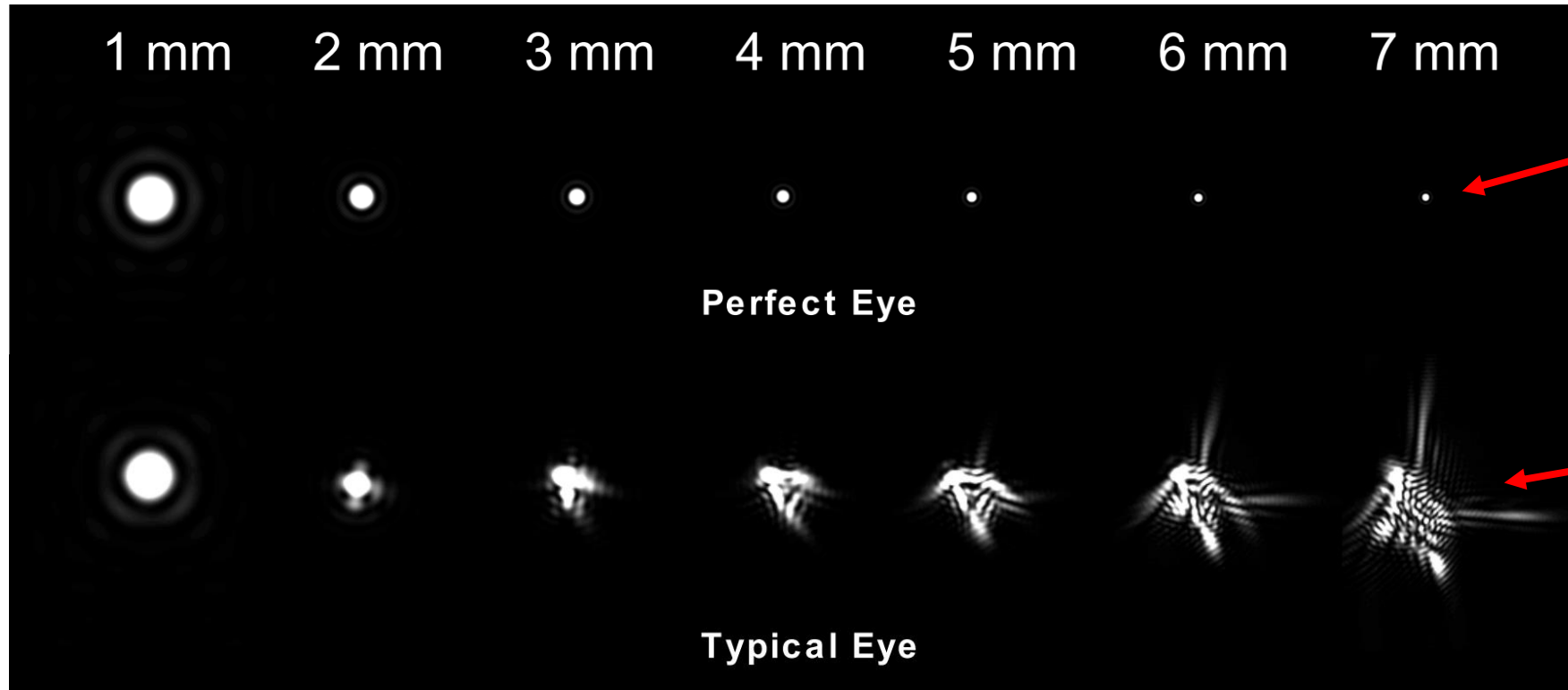

For a perfect eye, the focused spot of light on the retina gets smaller as pupil size increases

Imperfections (aberrations) in the optics of the eye cause large amounts of blur for large pupil sizes

To see individual cones at the center of the fovea ($\sim 2.5 \mu\text{m}$ in diameter), the combined optics (human eye plus AO system) must be almost perfectly corrected

Figures from Austin Roorda's SPIE Short Course lecture at the Wavefront Congress, titled "Optics and Image Quality in the Human Eye" and available for download from his website: <http://roorda.vision.berkeley.edu/>

Adaptive optics: an optical system which can dynamically adjust its optical properties in response to feedback

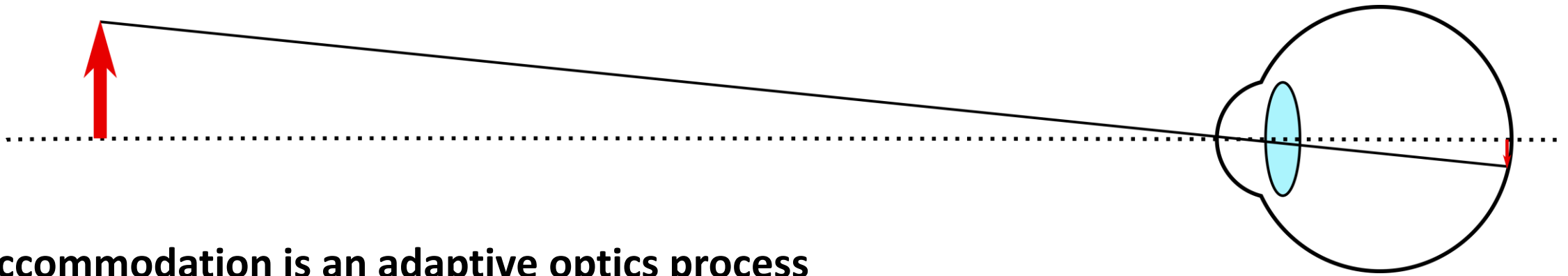

Accommodation is an adaptive optics process

Adaptive optics: an optical system which can dynamically adjust its optical properties in response to feedback

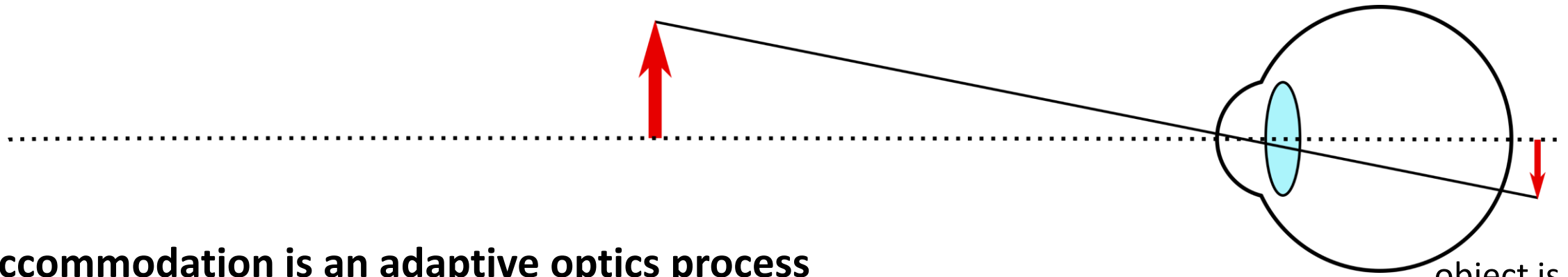

Accommodation is an adaptive optics process

object is out of focus on retina

Adaptive optics: an optical system which can dynamically adjust its optical properties in response to feedback

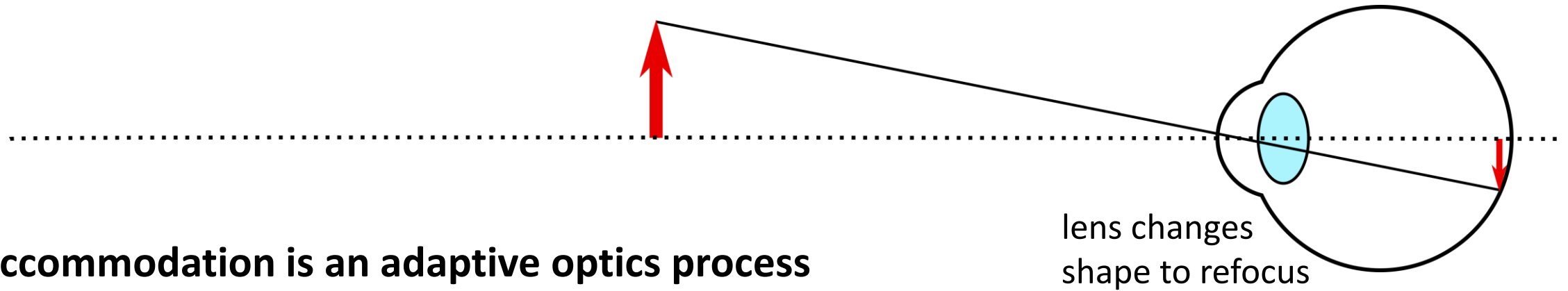

Accommodation is an adaptive optics process

- For accommodation, the lens changes shape to alter the eye's focal length
- This brings the image back into focus, but it doesn't fix the aberrations of the eye

Adaptive optics: an optical system which can dynamically adjust its optical properties in response to feedback

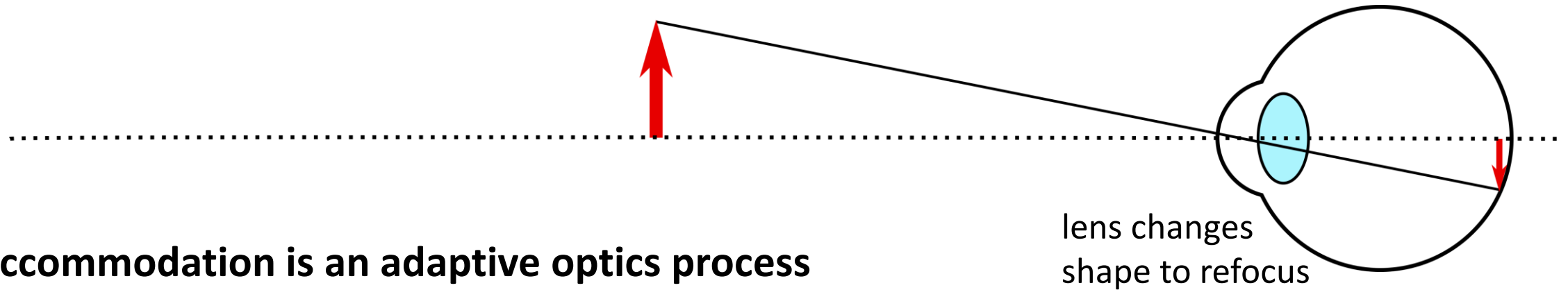

Accommodation is an adaptive optics process

- For accommodation, the lens changes shape to alter the eye's focal length
- This brings the image back into focus, but it doesn't fix the aberrations of the eye
- To correct the eye's aberrations, we need more degrees of freedom, finer resolution, and increased speed compared with accommodation

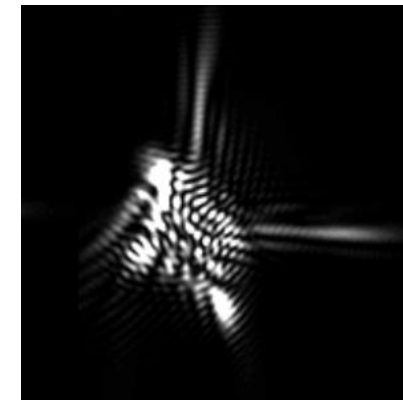

the focused spot of light on the retina is degraded due to aberrations

The AO system must be active to achieve good results over time

- The aberrations of the eye change over time, so the correction must be continuously adjusted
 - Long-term changes: eye growth and aging, refractive surgery
 - Medium-term: time of day
 - Short-term: time since last blink, accommodation, eye movements
- System must have a way of **measuring** and **compensating** for the aberrations in near-real-time

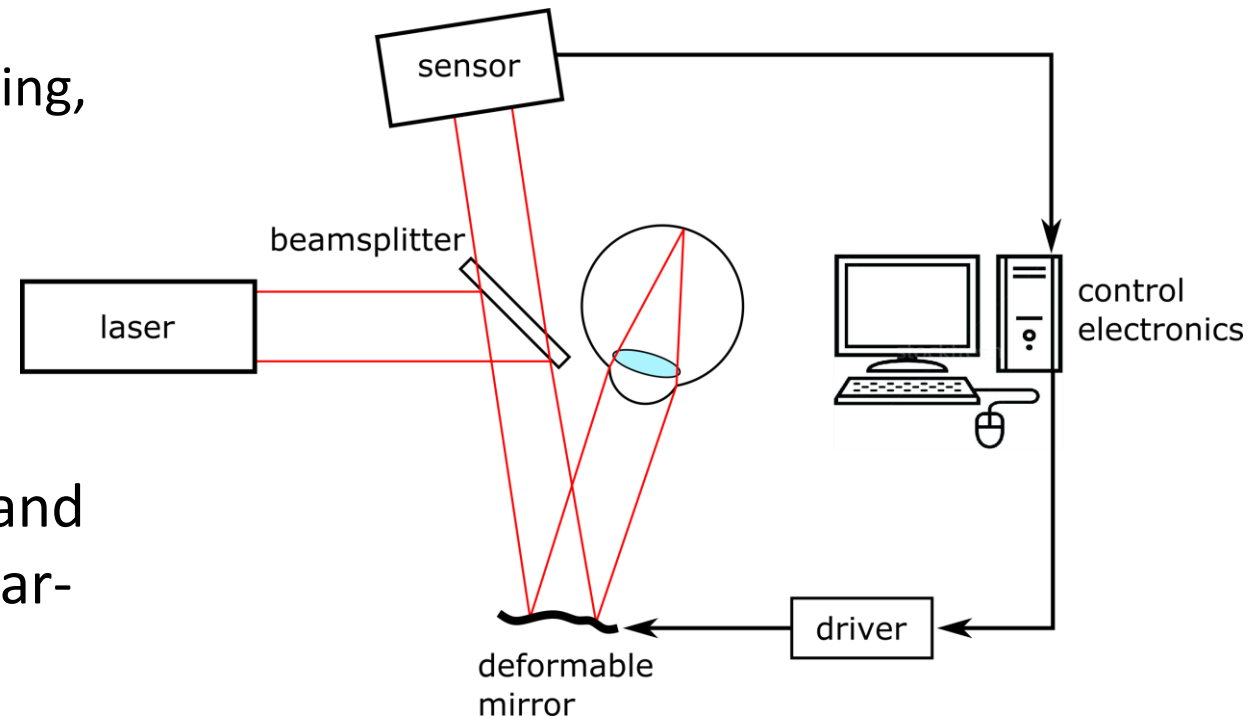

This system uses a wavefront sensor to measure aberrations and a deformable mirror to correct the aberrations

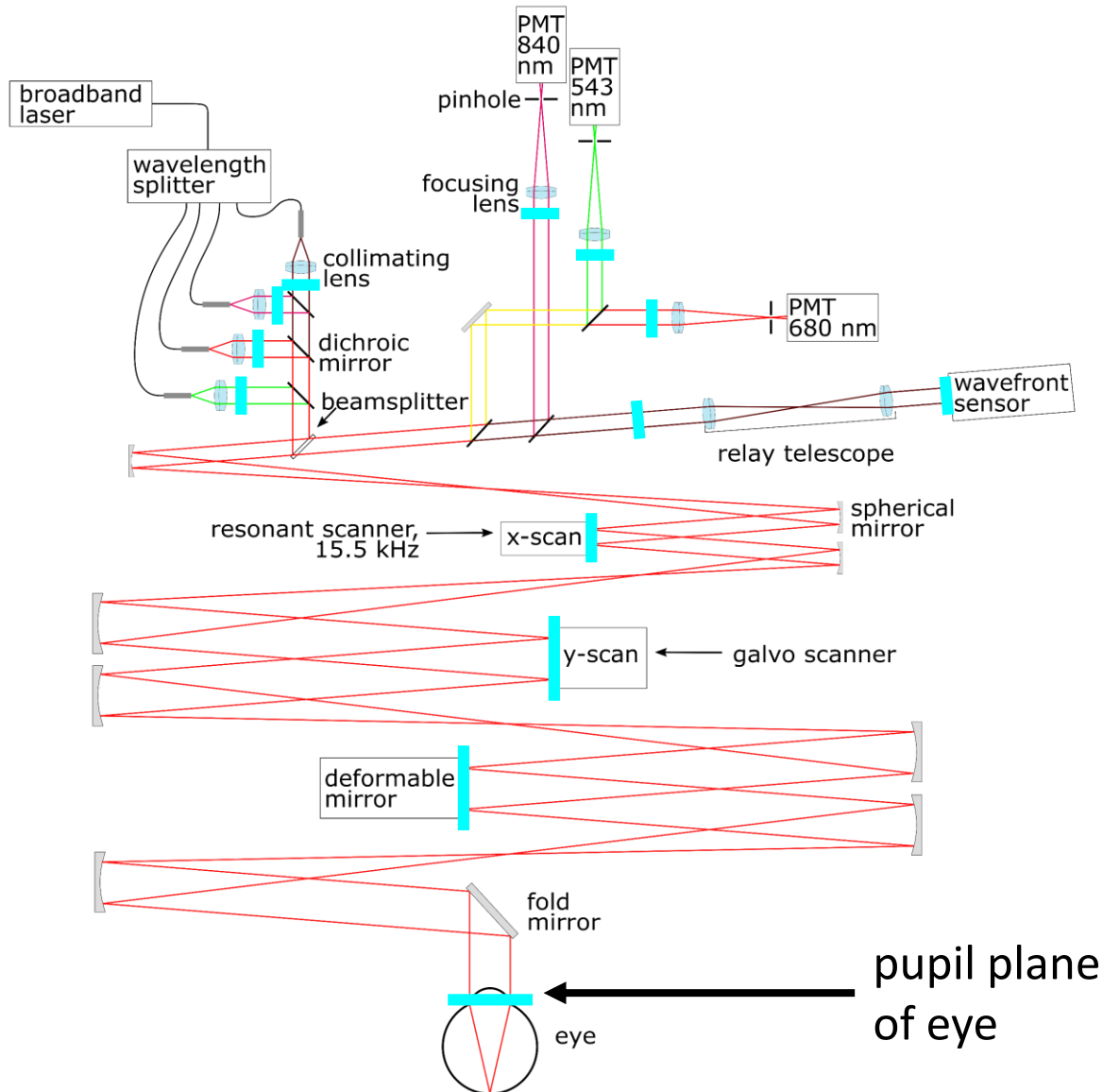

- Telescopes relay entrance pupil of the eye onto the scanners, the wavefront sensor, and the deformable mirror
 - This enables the **measurement** and **compensation** of aberrations measured at the pupil of the eye
 - We need the corrected wavefront at the eye's pupil to be perfectly planar
 - Achieving good pupil matching is critical for good imaging performance: this will require extensive alignment
 - Mirrors used for most telescopes to minimize chromatic aberration (dispersion)

The optical design has been optimized for high-resolution imaging of the fovea

Reflective afocal broadband adaptive optics scanning ophthalmoscope

Alfredo Dubra^{1,*} and Yusufu Sulai²

¹Flaum Eye Institute, University of Rochester, Rochester, NY, 14642-0314, USA

²The Institute of Optics, University of Rochester, Rochester, NY, 14627, USA

*adubra@cvs.rochester.edu

Abstract: A broadband adaptive optics scanning ophthalmoscope (BAOSO) consisting of four afocal telescopes, formed by pairs of **off-axis spherical mirrors in a non-planar arrangement**, is presented. The non-planar folding of the telescopes is used to simultaneously **reduce pupil and image plane astigmatism**. The former improves the adaptive optics performance by reducing the root-mean-square (RMS) of the wavefront and the beam wandering due to optical scanning. The latter provides **diffraction limited performance over a 3 diopter (D) vergence range**. This vergence range allows for the use of any broadband light source(s) in the 450-850 nm wavelength range to simultaneously image any combination of retinal layers. Imaging modalities that could benefit from such a large vergence range are optical coherence tomography (OCT), multi- and hyper-spectral imaging, single- and multi-photon fluorescence. The benefits of the non-planar telescopes in the BAOSO are illustrated by resolving the human foveal photoreceptor mosaic in reflectance using two different superluminescent diodes with 680 and 796 nm peak wavelengths, reaching the eye with a vergence of 0.76 D relative to each other.

©2011 Optical Society of America

Specifications

Frame rate	30 Hz
Fast scan rate	15.5 kHz
Full field of view	1.5°
Image size	512 x 512 pixels
Pixel size	10.5 arcsec (~0.8 μm)
WFS wavelength	940 nm
NIR imaging channel	840 nm
Visible imaging/stimulus delivery channels	543 nm (green), 680 nm (red)

We're building the system based on a blueprint provided by Austin Roorda and his lab at UC Berkeley

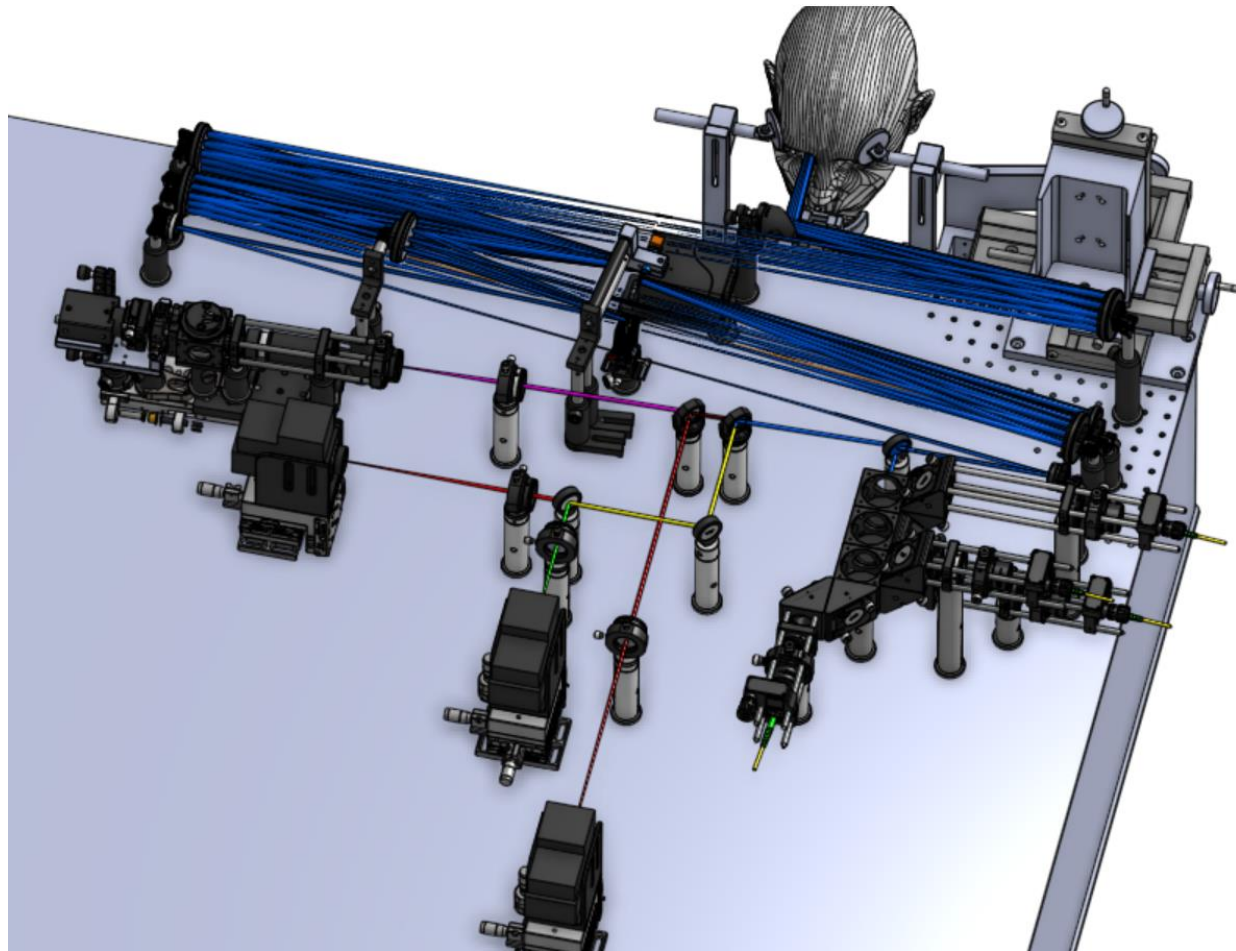

CAD drawing of assembled AO system

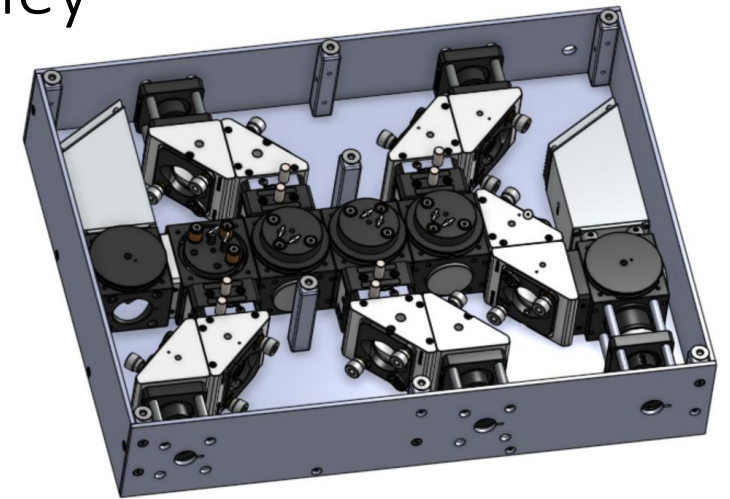

CAD drawing of wavelength splitter

#	Name	Part #	Maker	Unit	Quant	Price
2	DELIVERY					
3	1 Right-Angle Kinematic Mirror Mount with Smooth Cage Rod Bores	KCB1C/M	Thorlabs	\$ 147.29	4	\$ 589.16
4	2 Right-Angle Kinematic Mirror Mount with Tapped Cage Rod Holes	KCB1M	Thorlabs	\$ 147.29	4	\$ 589.16
5	3 Cage Assembly Rod, 1/4" (6.4 mm) Long, Ø6 mm	ER025	Thorlabs	\$ 5.20	32	\$ 166.40
6	4 30 mm Cage Cube: 6 mm Through Holes	C6W	Thorlabs	\$ 67.63	3	\$ 202.89
7	5 Kinematic Cage Cube Platform for C4W/C6W, Metric	B4C/M	Thorlabs	\$ 104.42	3	\$ 313.26
8	6 Blank Cover Plate with Rubber O-Ring for C4W/C6W, Metric	B1C/M	Thorlabs	\$ 19.91	3	\$ 59.73
9	7 30 mm Cage System, XY Translating Lens Mount for Ø1" Optics	CXY1	Thorlabs	\$ 187.20	4	\$ 748.80
10	8 Z-Axis Translation Mount for 30 mm Cage System	SM1Z	Thorlabs	\$ 205.60	4	\$ 822.40
11	9 Graduated Ring-Actuated SM1 Iris Diaphragm	SM1D12C	Thorlabs	\$ 109.29	4	\$ 437.16
12	10 Cage Plate Stops for ER Rods (4 Pack)	ERCPS	Thorlabs	\$ 44.64	2	\$ 89.28
13	11 Externally SM1-Threaded Plug	SM1PL	Thorlabs	\$ 15.48	3	\$ 46.44
14	12 FC/APC Fiber Adapter Plate with External SM1 (1.035"-40) Thread	SM1FCA	Thorlabs	\$ 33.28	4	\$ 133.12
15	14 1" Optic Mount for 30mm Cube	B5C1	Thorlabs	\$ 33.28	3	\$ 99.84
16	15 Cage Assembly Rod, 6" (152.4 mm) Long, Ø6 mm, 4 Pack	ER6-P4	Thorlabs	\$ 33.86	2	\$ 67.72
17	16 Cage Assembly Rod, 10" (254.0 mm) Long, Ø6 mm	ER10	Thorlabs	\$ 13.08	4	\$ 52.32
18	17 SM1-Threaded 30 mm Cage Plate, 0.35" Thick, 2 Retaining Rings, M4 Tap	CP33/M	Thorlabs	\$ 16.89	4	\$ 67.56
19	18 Cage Assembly Rod, 8" Long, Ø6 mm	ER8-P4	Thorlabs	\$ 45.79	1	\$ 45.79
20	19 Ø25.0 mm Pedestal Pillar Post, M4 Taps, L = 100 mm	RS4P4M	Thorlabs	\$ 34.36	3	\$ 103.08
21	20 Ø25 mm Post Spacer Thickness = 5 mm	RS5M	Thorlabs	\$ 8.17	2	\$ 16.34

parts list with all system components

Nearly all components have arrived
and are nicely organized for efficient assembly



- Some of the electronics still need to be ordered (FPGA, computer, etc.)
- These will be ordered once labs reopen and shipments can be received
- Assembly and alignment of the optical system can proceed without these additional electronics

Optics, mechanical components, and electronics are nicely organized and labeled, which will make assembly of the system more efficient

Wavelength splitter mechanical assembly is finished and light delivery stage assembly has begun

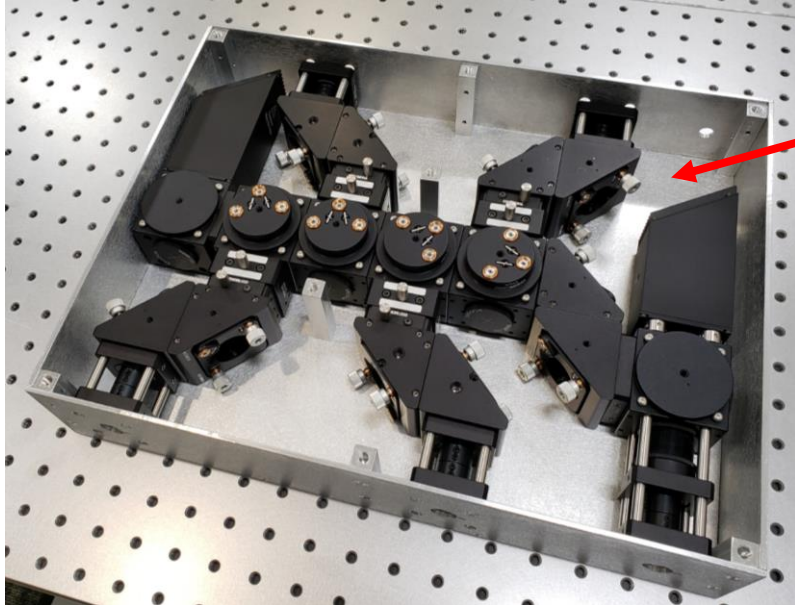

Mechanical assembly completed; just need to install and align optics



Stencil was made using high-precision laser cutter; this will allow for easy component placement and initial alignment

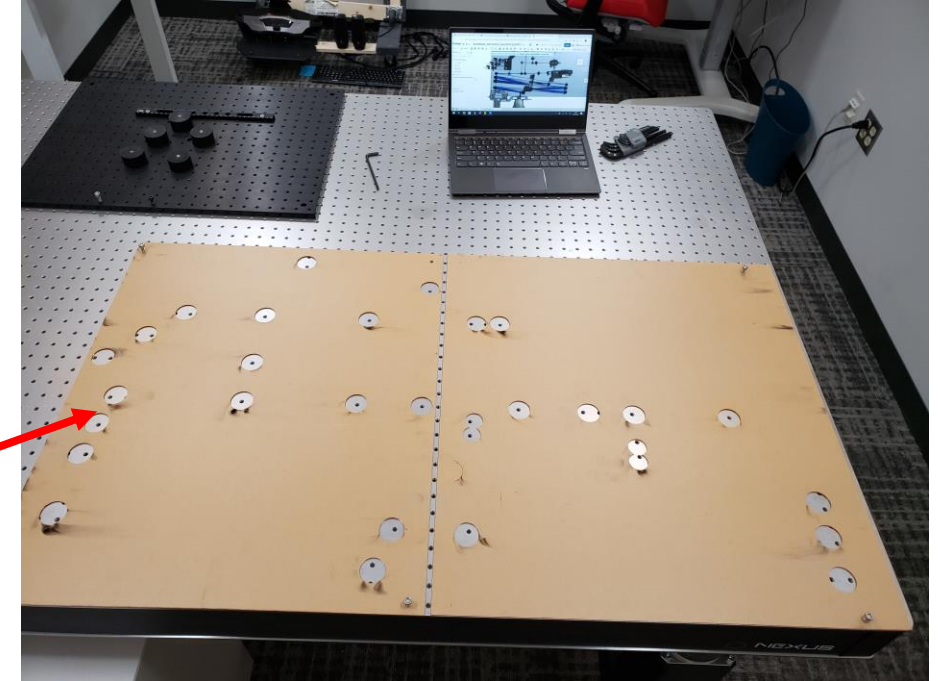

Mechanical assembly of light delivery stage of AO system was started before the labs closed (no optics installed yet)

While the labs are closed, I will work on optical modeling for the system and reading up on best alignment techniques

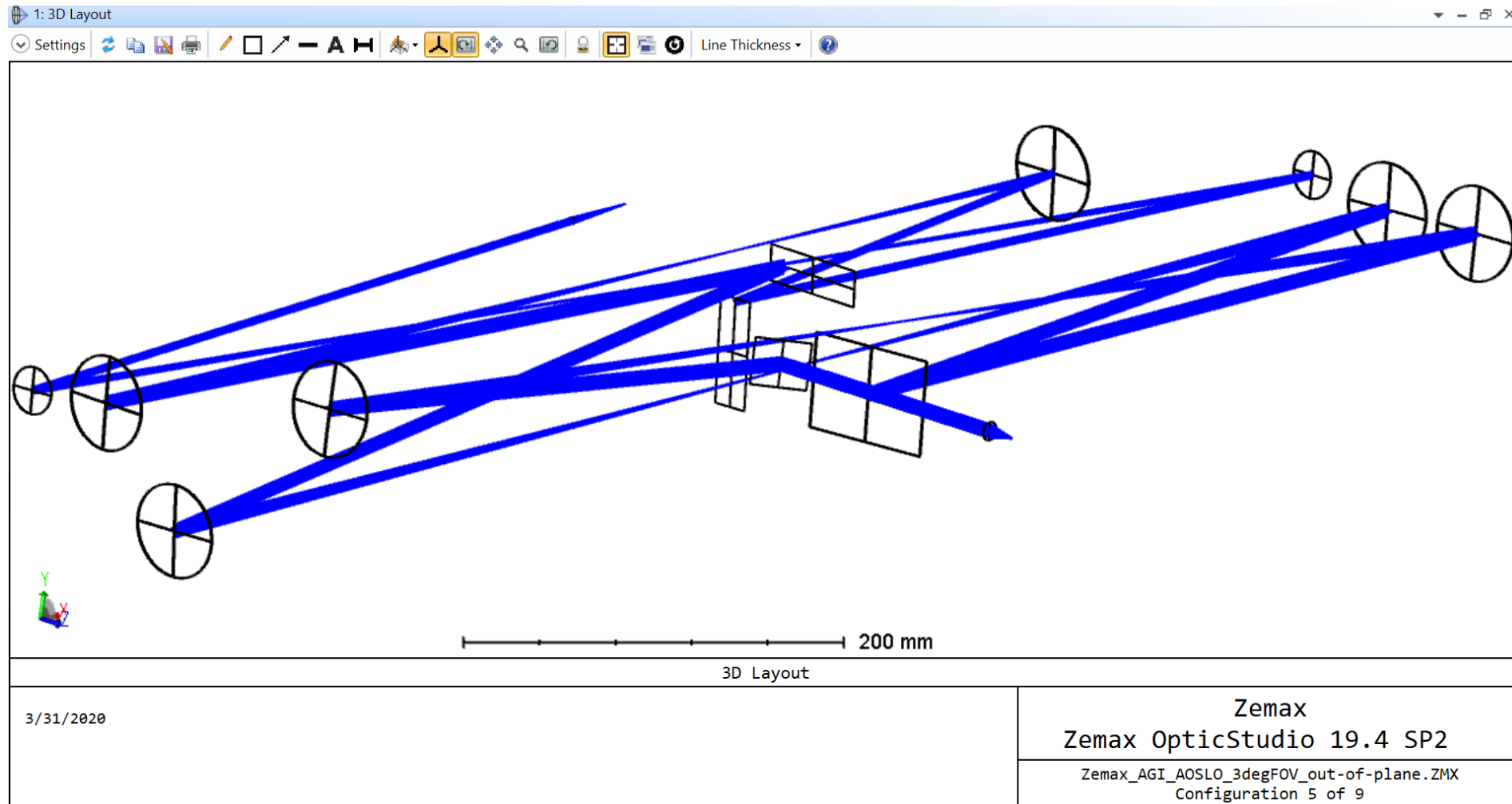

- Zemax model provided by Roorda lab
- Will replicate model in CODE V because I'm more familiar with it
- Run sensitivity analysis on entire system, which will help with alignment

Optical layout for the system in Zemax, an optical design software package

Once labs reopen, we can continue assembling and aligning the optical system

- Laser has arrived, so we now have all the equipment we need to test alignment
- Plan for resuming work on the system:
 1. Install optics in wavelength splitter assembly
 2. Align wavelength splitter and verify proper performance
 3. Finish building light delivery stage and align optics
 4. Assemble the relay telescopes and verify alignment of each subsystem
 5. Install scanning and adaptive optics hardware
 6. Implement adaptive optics control algorithms
 7. Begin testing performance of full system

The system uses a Class IV laser,
so proper laser safety must be followed to prevent injury



**Laser emits 1,000 X the limit for eye safety in the visible wavelengths,
plus another 4 W of optical power in NIR and IR wavelengths**

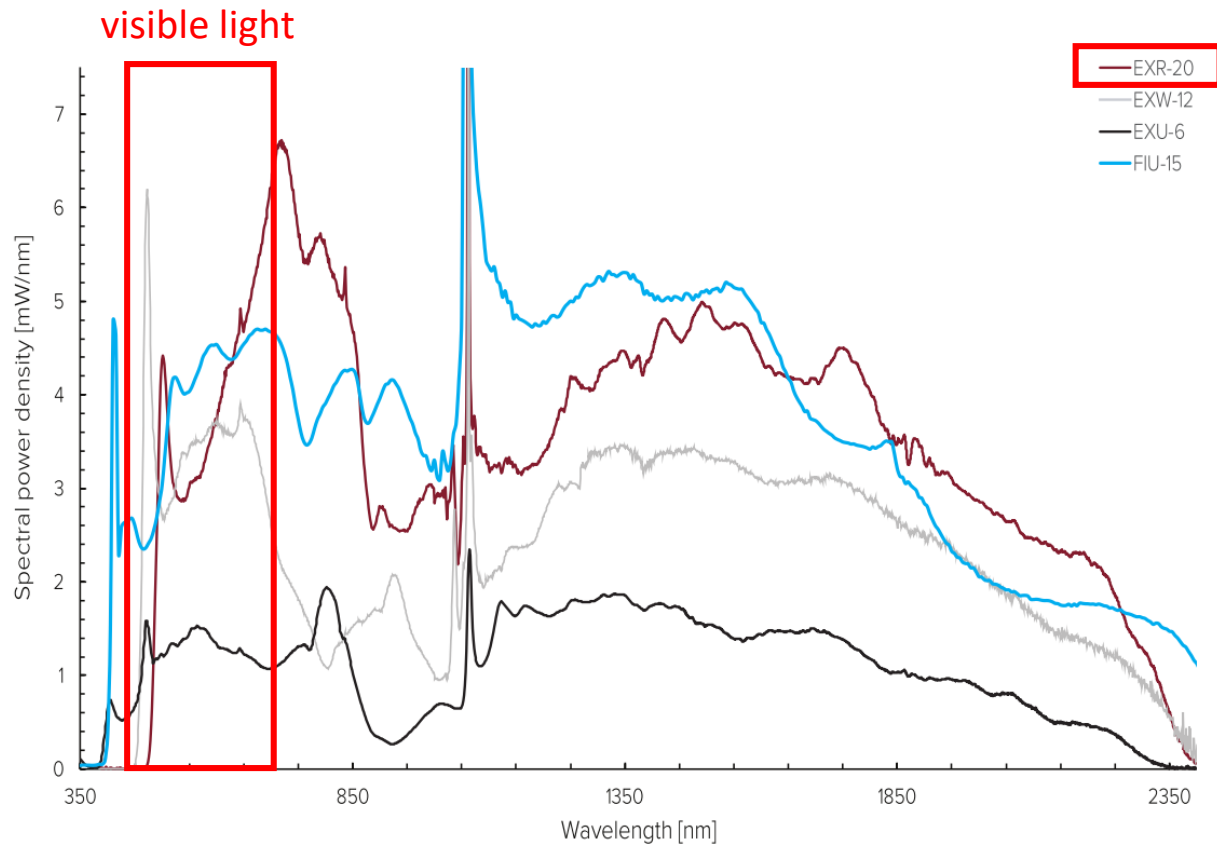

Model	Cut-in >0.1 mW/nm	Visible power (350-850 nm)	Total power
EXR-4	535 nm	400 mW	2 W
EXU-6	390 nm	600 mW	2 W
EXW-12	455 nm	1200 mW	4 W
EXR-15	475 nm	1500 mW	4.5 W
FIU-15	410 nm	1800 mW	5.5 W
EXR-20	470 nm	2000 mW	6 W

Following proper laser safety protocols will prevent injury during alignment and operation of the system

- Most laser safety concerns will only be an issue during alignment
 - Once system is assembled and aligned, engineering controls will prevent accidental exposure
 - Dichroics and filters will be used to limit optical power to eye safe levels before any human subject tests are conducted

Alignment protocols

- Only experienced personnel should do alignment
- Door to AO room must remain closed when alignment is taking place
- Lowest possible laser power setting should always be used
- Keep beam confined to a plane parallel to the table, and never move head close to this plane

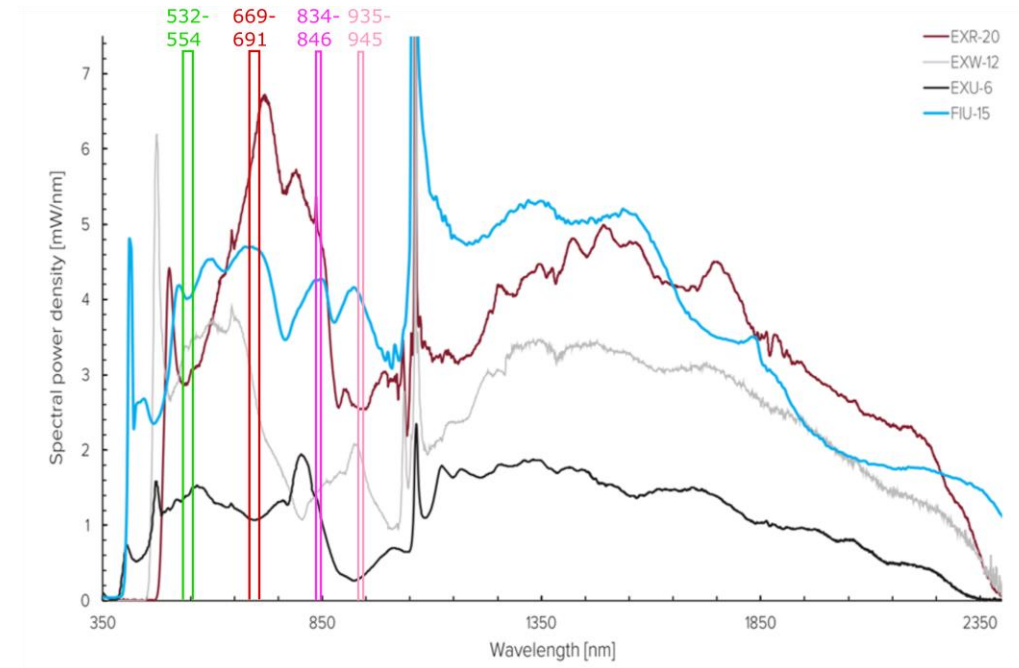

Thank you for watching this presentation!

I welcome any questions
or feedback you
might have

